

SERVICE MANUAL

COLOR TELEVISION

- This Service Manual contains the additional information "NOTICES BEFORE REPAIRING", "DISASSEMBLY INSTRUCTIONS" and "ADJUSTMENT" for the model TV-S2011 (U). If requiring the other information, see Service Manual of TV-S2011 (U), (S/M Code No: 09-99C-416-8R2).

aiwa
S/M Code No. 09-003-416-8S1

SUPPLEMENT
DATA

NOTICES BEFORE REPAIRING

To make the best use of this equipment, make sure to obey the following items when repairing (or mending).

1. Do not damage or melt the tunicate of the leading wire on the AC1 side, including the power supply cord.
2. Do not soil or stain the letters on the spec. inscription plates, notice labels, fuse labels, etc.
3. When repairing the part extracted from the conducted side of the board pattern, fix it firmly with applying bond to the pattern and the part.
4. Restore the following items after repairing.
 - 1) Conditions of soldering of the wires (especially, the distance on the AC1 side).
 - 2) Conditions of wiring, bundling of wires, etc.
 - 3) Types of the wires.
 - 4) Attachment conditions of all types of the insulation.
5. After repairing, always measure the insulation resistance and perform the voltage-withstand test (See Fig-1).
 - 1) The insulation resistance must be 1.5 to 3.0 M Ω when applying 500V per second.
 - 2) In the voltage withstand test, apply 1.2 kV for 1 minute and check that the GO lamp lights.

- * Breaking current set to 10 mA.
- * Connect the safety checker as shown in Fig-1, then measure the resistance and perform the test.
- * Do not touch the equipment during testing.
- * For details of the safety checker, refer to the supplied Operation manual.

Insulation resistance: 1.5 to 3.0 M Ω (500 V/s)
Voltage-withstand: 1.2 kV for 1 minute

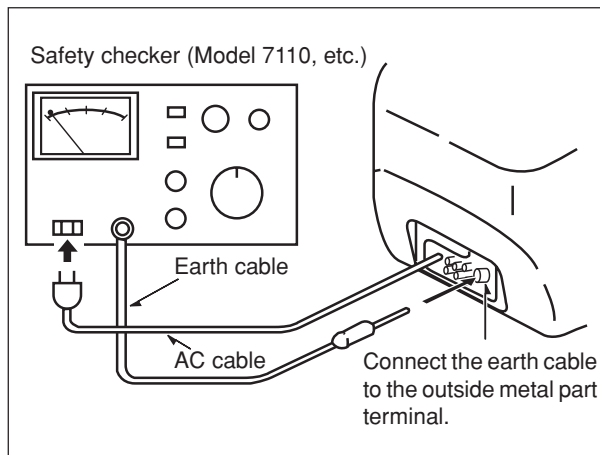

Fig-1

When servicing and checking on the TV, note the followings.

1. Keep the notices.

As for the places which need special attentions, they are indicated with labels or seals on the cabinet, chassis and parts. Make sure to keep the indications and notices in the operation manual.
2. Avoid an electric shock.

There is a high voltage part inside. Avoid an electric shock while the electric current is flowing.
3. Use the designated parts.

The parts in this equipment have the specific characteristics of incombustibility and withstand voltage for safety. Therefore, use a part which has the same character as the replaced part. Especially as to the important parts for safety which is indicated in the circuit diagram or the table of parts with a Δ mark, the designated parts must be used.
4. Put parts and wires in the original position after assembling or wiring.

There are parts which use the insulation material such as a tube or tape for safety, or which are assembled so that these parts do not make contact with the printed board. The inside wiring is designed not to get close to the pyrogenic parts and high voltage parts. Therefore, put these parts in the original positions.
5. Take care of the cathode-ray tube.

By setting an explosion-proof cathode-ray tube in this equipment, safety is secured against implosion. However, when removing it or servicing from the back, it gives out shock that is dangerous. Take enough care to deal with it.
6. Avoid an X-ray.

Safety is secured against an X-ray by giving considerations to the cathode-ray tube and the high voltage peripheral circuit, etc. Therefore, when repairing the high voltage peripheral circuit, use the designated parts and do not change the circuit. Repairing, except indicates, causes rising of high voltage, and the cathode-ray tube emits an X-ray.
7. Perform a safety check after servicing.

Confirm that the screws, parts and wiring which were removed in order to service are put in the original positions, or whether there are deteriorated portions around the places serviced.

Δ Safety Components Symbol

This symbol is given to important parts which serve to maintain the safety of the product, and which are made to confirm to special Safety Specifications. Therefore, when replacing a component with this symbol make absolutely sure that you use a designated part.

DISASSEMBLY INSTRUCTIONS

1. REAR CABINET REMOVAL

- (1) Remove four screws ①, two screws ② and one ③, then remove the rear cabinet in the direction of the arrow. (See Figure 1-1)

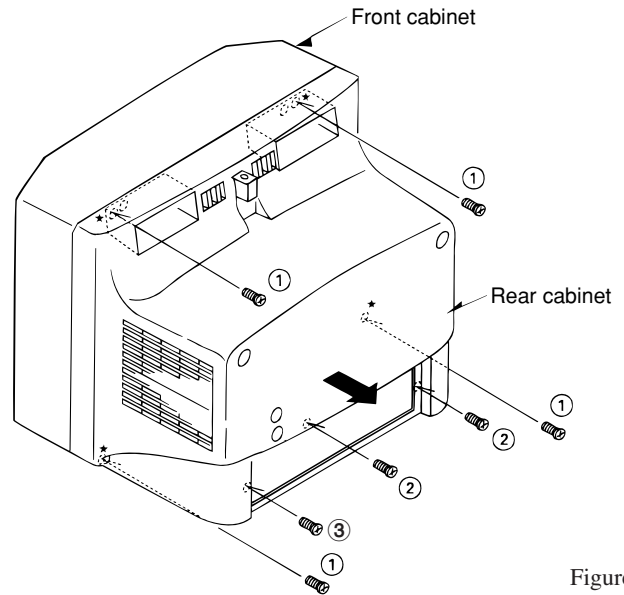

Figure 1-1

2. HIGH-VOLTAGE CAP (ANODE CAP) REMOVAL

2-1. Cautions before Removing

Discharge the anode voltage

- (1) The anode voltage is not discharged completely from the CRT of this unit even after the power is turned off. Be sure to discharge the residual anode voltage before removing the anode cap.

Do not use pliers

- (2) Do not use pliers, etc. to remove the anode cap. If you used pliers and bent the hook to remove the cap, the spring characteristics of the hook could be lost, and when reinstalled, the cap would come off from the CRT anode button easily, causing an accident.

Do not turn the anode cap

- (3) If the anode cap is turned in the direction of its circumference, the hook is likely to come off.

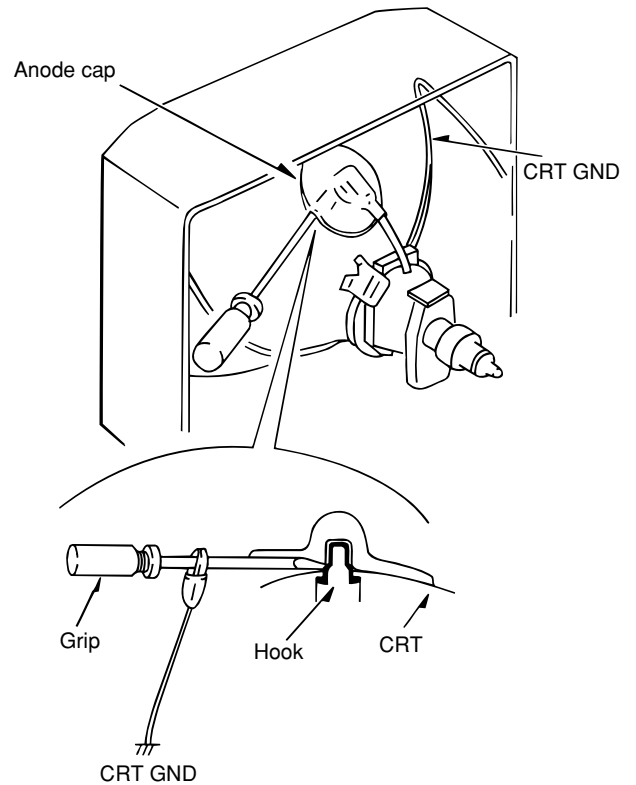

Figure 2-1

2-2. Anode Cap Removal

Discharge the anode voltage. (See Figure 2-1)

- (1) Connect a flat-bladed screwdriver to the CRT GND via an alligator clip.
- (2) Use a tester to check the end of the screwdriver and ground of the TV for continuity.
- (3) Touch the hook with the end of the screwdriver.
Caution : Be careful not to damage the anode cap.
- (4) Turn over the anode cap.
Caution : Be careful not to damage the anode cap.

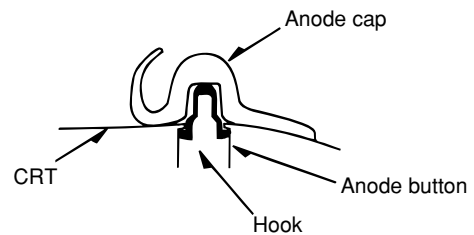

Figure 2-2

- (5) Push the anode cap with your thumb in the direction of arrow ① as shown in the figure, then lift the cap in the direction of arrow ② to release the hook on one side. (See Figure 2-3)

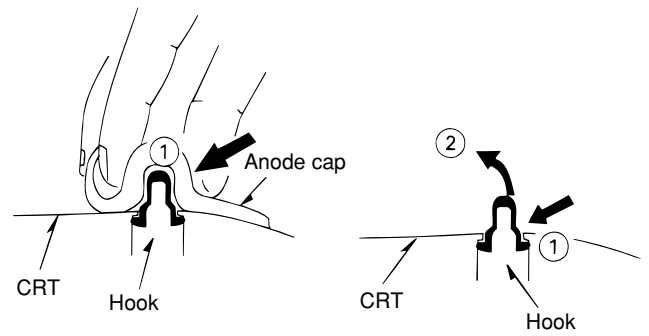

Figure 2-3

- (6) Turn over the anode cap on the side where the hook was released and pull out the cap in the direction opposite to that on which the cap was pushed. (See Figure 2-4)
Caution : Do not pull out the anode cap straight up.
 : Do not pull the cap forcibly. After removing the cap, check that the hook is not deformed.

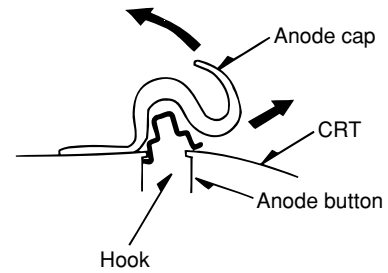

Figure 2-4

3. ANODE CAP REINSTALLTION

Observe the cautions carefully so that no accident occurs due to a defect in installing the anode cap and so it does not come off.

3-1. Caution before Reinstalling

Never turn the anode cap after installing it

Never re-use the hook when it has been deformed

- (1) If the anode cap is turned after it is installed, it may come off. Therefore, arrange the high-voltage cable before attaching the anode cap. (See Figure 3-1)
- (2) If you have attached the anode cap before arranging the high-voltage cable, arrange the cable carefully so the cap does not turn.

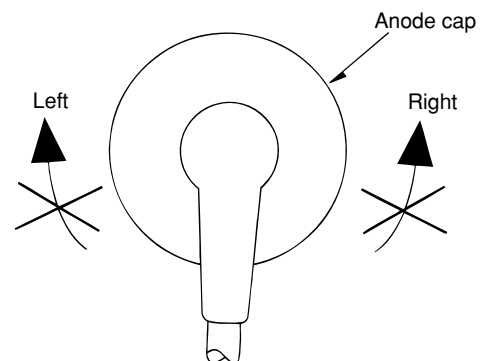

Figure 3-1

3-2. Anode cap reinstallation

- (1) Use a clean cloth moistened slightly with alcohol to clean the installation section. (See Figure 3-2)
Caution : Check that the installation section is free from dust, foreign matter, etc.
- (2) Coat the anode cap installation circumference with an appropriate amount of the specified silicone grease (KS-650N).
Caution : Be careful that silicone grease does not enter the anode button.

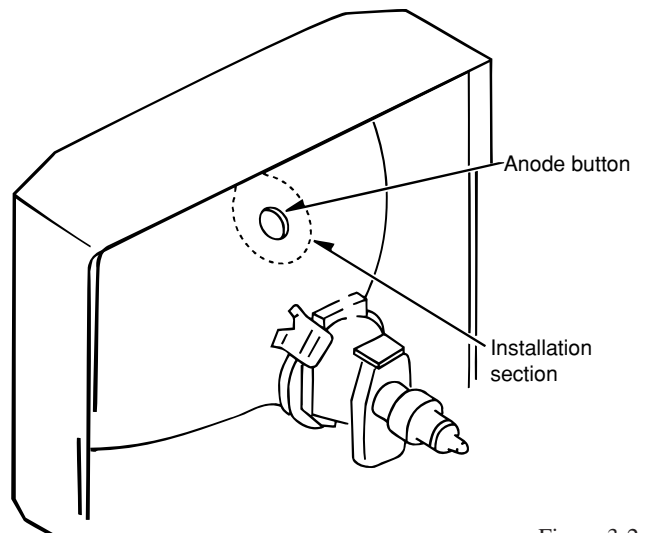

Figure 3-2

- (3) Eliminate twisting, etc. of the high-voltage cable and arrange it so that no twisting occurs. (See Figure 3-3)
Caution : If the cable is not arranged correctly, the anode cap could turn and cause an installation defect.

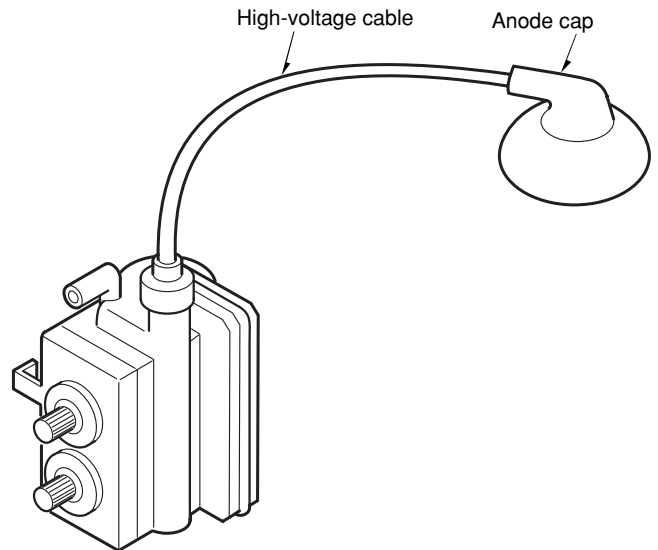

Figure 3-3

- (4) Turn over the rubber cap symmetrically on the left and right. (See Figure 3-4)
Caution : Take great care not to damage the anode cap.

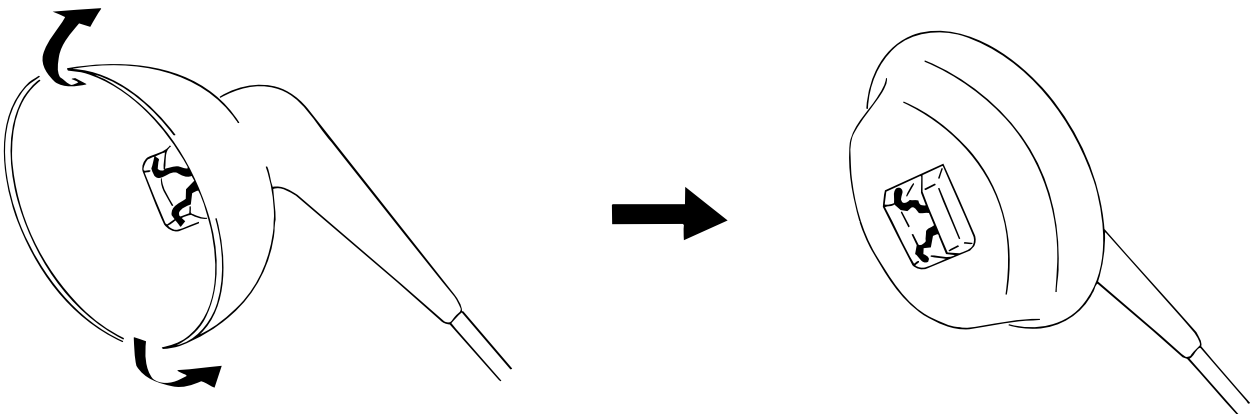

Figure 3-4

- (5) Fit your forefinger over the projection at the center of the cap and hold the cap between your thumb and middle finger. (See Figure 3-5)

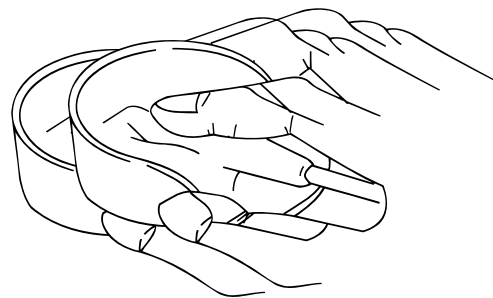

Figure 3-5

- (6) Apply the hook on one side to the anode button as shown on the figure. (See Figure 3-6)
Caution : Check that the hook is held securely.
- (7) Apply the hook on the other side to the anode button as shown in Figure 3-7.

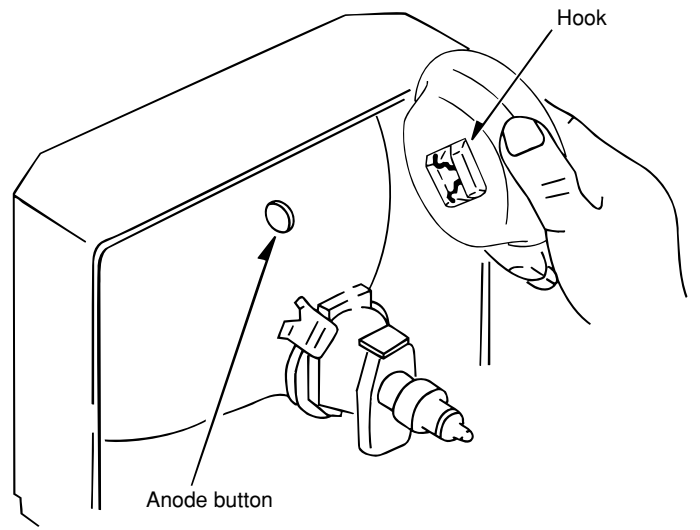
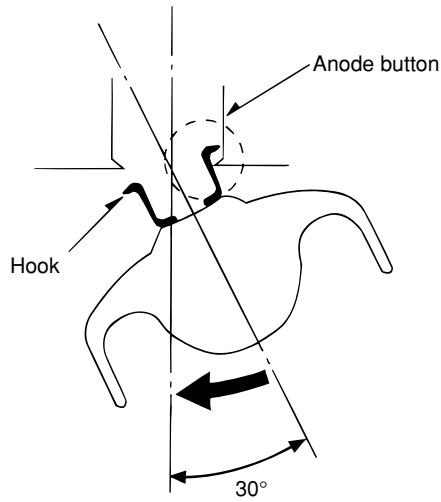

Figure 3-6

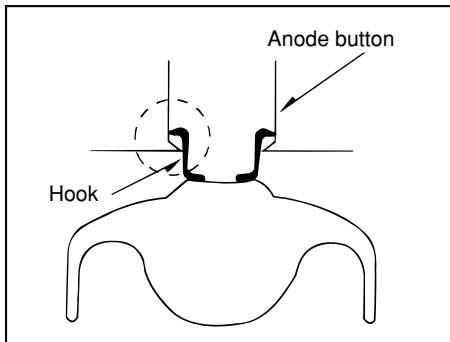

Figure 3-7

- (8) Pull the anode cap slightly with the rubber cap turned over and visually check that the hook is engaged securely.
- (9) Release your hand from the rubber cap of the anode cap.
Caution : Cover the anode cap so that it does not lift.
- (10) Hold the skirt of the anode cap slightly to improve the close contact between the cap and CRT.
- (11) Check that the anode cap is in close contact with the CRT. (See Figure 3-8)

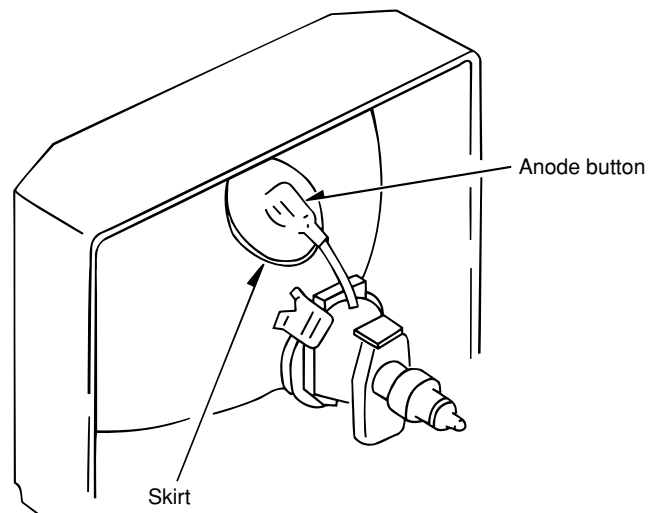

Figure 3-8

4. NK C.B REMOVAL

- (1) Disconnect CN904 (CRT GND).
- (2) Disconnect CN901, CN902.
- (3) Remove the NK C.B. in the direction of arrow ①.
(See Figure 4-1)

5. MAIN C.B REMOVAL

- (1) Remove connector (CN401).
- (2) Remove connector (CN801).
- (3) Remove connector (CN802).
- (4) Pull out the MAIN C.B. in the direction of the arrow ②
(See Figure 4-1).

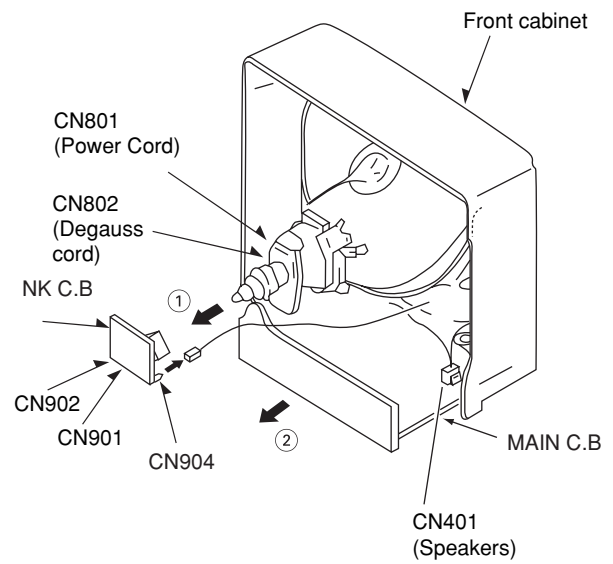

Figure 4-1

ADJUSTMENT

Set-Up For Adjustment

Because the video signal output from a pattern generator is used as the adjustment signal input during adjustment, the video signal output from the pattern generator must conform with the specifications. Measure the output waveform across $75\ \Omega$ load. Confirm that the synchronizing signal has an amplitude of about 0.3 V, the video signal portion has an amplitude of about 0.7 V and the burst signal has an amplitude of about 0.3 V with flat envelope. Confirm that ratio of the burst signal amplitude and the red signal amplitude is 0.30 : 0.66. If the output signal does not conform with the specifications, calibrate the pattern generator. (Refer to pattern generator operation manual.)

Use the LEADER: LCG 404 for the pattern generator.

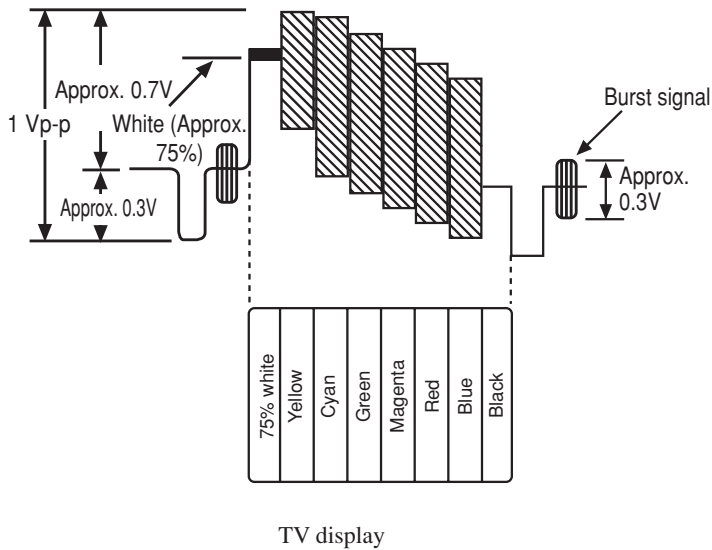

Color bar signal of a pattern generator

Precautions Before Starting Adjustment

Satisfy the following setting conditions before starting adjustment.

- Allow warm-up of 20 minutes or longer. (Do not turn off during warm-up.)
- Set all picture quality controls of users' setting to initial set-up, unless otherwise specified.
- Picture quality reset
 1. Select "Picture" on the screen menu and press enter button.
 2. Select "Normal" and press enter button.
 3. Select "Reset" and press enter button.
- Set the pattern generator's output level to 1.0Vp-p (across $75\ \Omega$ load).

1. CRT Adjustment

1-1. Precautions

- (1) Receive the white raster signal, and then perform aging for at least 20 minutes.
- (2) Demagnetize the area surrounding the CRT with a degausser before making adjustments.
- (3) Set the picture quality for each mode to the factory setting.
- (4) Position the front screen facing the east as much as possible.

1-2. Purpose

- (1) Beam landing adjustment (purity magnet)

Set the left/right balance of beam landing. If there is a discrepancy in this adjustment, a color irregularity will occur. After completion of the landing adjustment, it is necessary to perform convergence adjustment.

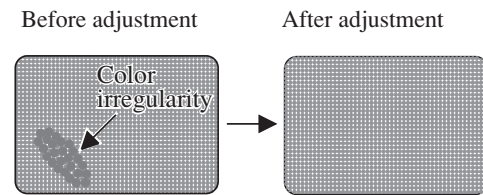
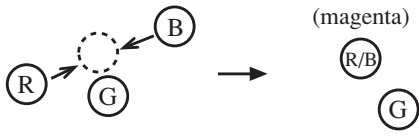

Fig. 1-1

(2) Beam convergence adjustment (4-pole magnet)

Align the R beam with the B beam. The G beam does not move with this adjustment.



Align the R beam with the B beam
Fig. 1-2

(3) Beam convergence adjustment (6-pole magnet)

With a 4-pole magnet align the G beam with the already aligned R/B beam.

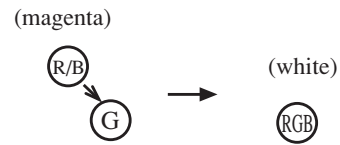

Align the G beam with the R/B beam
Fig. 1-3

(4) The composition of each magnet is as shown in Fig. 1-4.

In making adjustments, rotate the lock ring clockwise (looking from the CRT's back screen) and disengage.

Be careful not to loose the lock ring too much. If the magnet assembly has become shifted during adjustments, secure it to the position in Fig. 1-4.

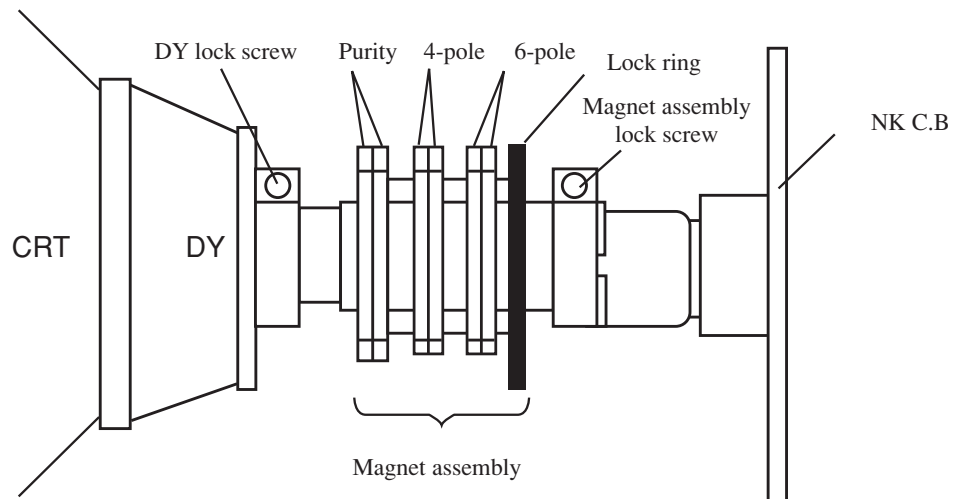

Fig 1-4

1-3. Beam Landing Adjustment

- (1) Receive the green raster signal from the pattern generator.
- (2) Loosen the magnet lock screw, and shift the magnet assembly backward (toward the neck).
- (3) Loosen the DY lock screw, and shift the DY deflecting yoke backward (toward the neck).
- (4) After opening the two purity magnets to the same angle, adjust the color width of the bands on both sides of the screen so that they are equal. (refer to Fig. 1-5 (a)).

As shown in Fig. 1-5 (b), the purity magnet functions in relation to

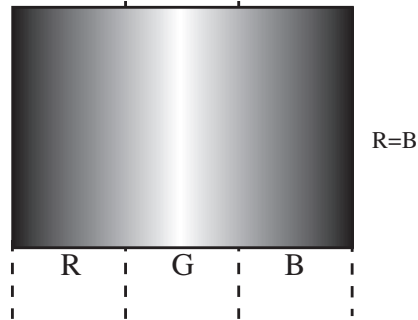

Fig 1-5 (a)

the electron beam.

- (5) Gradually shift the deflecting yoke toward the front (toward the CRT funnel). Stop movement at the point when the screen has become completely green.
- (6) Also, verify the respective monochromatics of red and blue.

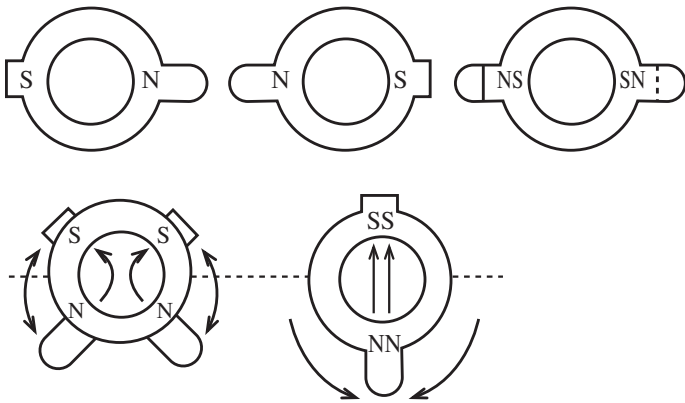

Fig 1-5 (b)

- (7) While looking at the screen, adjust the tilt of the deflecting yoke and tighten the DY lock screw.
- (8) Shift the magnet assembly to the front (toward the CRT funnel), stop movement before the adjustment position and then tighten the magnet lock screw.

At this time, be careful not to shift the position of the purity magnet.

As there is occurrence of convergence distortion after completing the landing adjustments, be sure to carry out convergence adjustments.

If the color irregularities in the screen's corner section are not improved, correct them with the landing magnet. After using the landing magnet, be sure to demagnetize the CRT with degausser and verify that there is no occurrence of color irregularity. (refer to Fig. 1-6)

Landing magnet: 81-JTI-710-010

(two-sided adhesive tape) : 80-XVI-218-010 Cushion

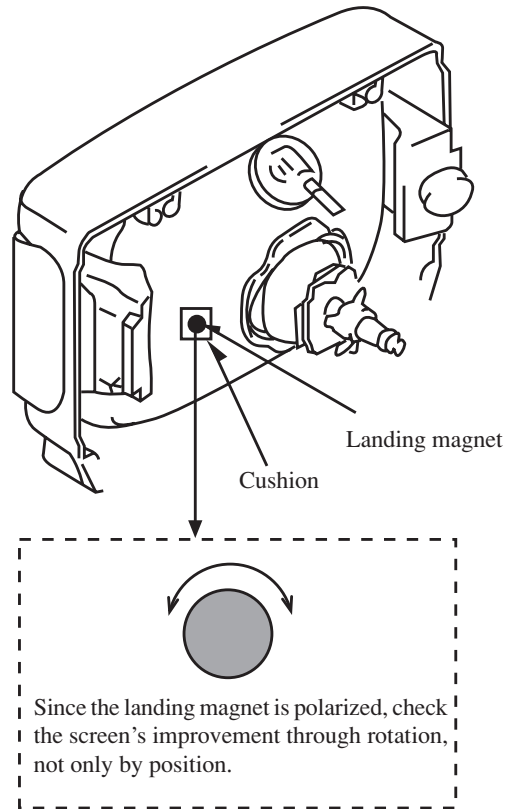

Fig 1-6

1-4. Beam Center Convergence Adjustment

Make adjustments on the convergence with 4-pole and 6-pole magnets. Operate each magnet in relation to the electron beam as shown in Figs. 1-7 and 1-8. When performing this adjustment, verify whether there is distortion in the focus adjustment. If necessary, carry out adjustments again.

In Fig. 1-7, two 4-pole magnets are stacked together so as to be of the

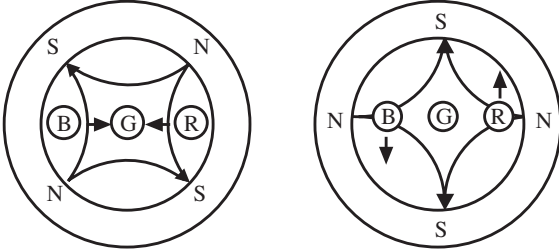

Fig 1-7

same polarity. Move the B and R beams to their respective direction, by rotating the two 4-pole magnets together. By adjusting the opening of the two magnets, it is possible to adjust the amount of the beam's movement.

In Fig. 1-8, the two 6-pole magnets are stacked together so as to be of

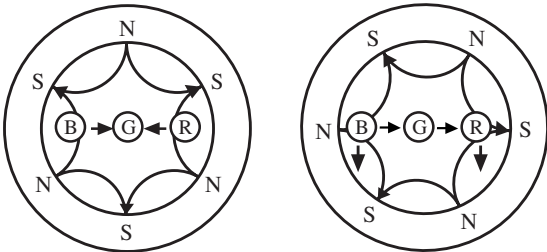

Fig 1-8

the same polarity. Move the B and R beams to their respective direction, by rotating the two 6-pole magnets together. By adjusting the opening of the two magnets, it is possible to adjust the amount of the beam's movement.

- (1) Receive the dot pattern signal from the pattern generator.
- (2) Pay attention to the center of the screen, and perform adjustments with two 4-pole magnets so that the R beam and B beam are perfectly aligned and become a magenta color. (Refer to Fig. 1-2)
- (3) In the same way, pay attention to the screen, and perform adjustments with a 6-pole magnet so that the magenta beam and G beam are aligned and become a white dot. (Refer to Fig. 1-3)
- (4) After adjustments are completed, secure all magnets with the lock link. (Refer to Fig. 1-4)

1-5. The Surrounding Convergence Adjustment

Perform this adjustment after completion of adjustment 1-4.

- (1) Shake the deflecting yoke up, down to the right and left, and adjust any discrepancies in the screen's surroundings.
- (2) Insert wedges in three locations in the gap between the deflecting yoke and the surface of the CRT funnel in order to secure the deflecting yoke. (Refer to Fig. 1-9)

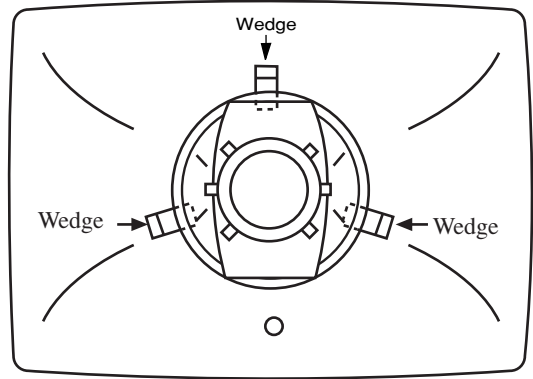

Position of wedge

Fig. 1-9

A MAIN C. B (Top View)

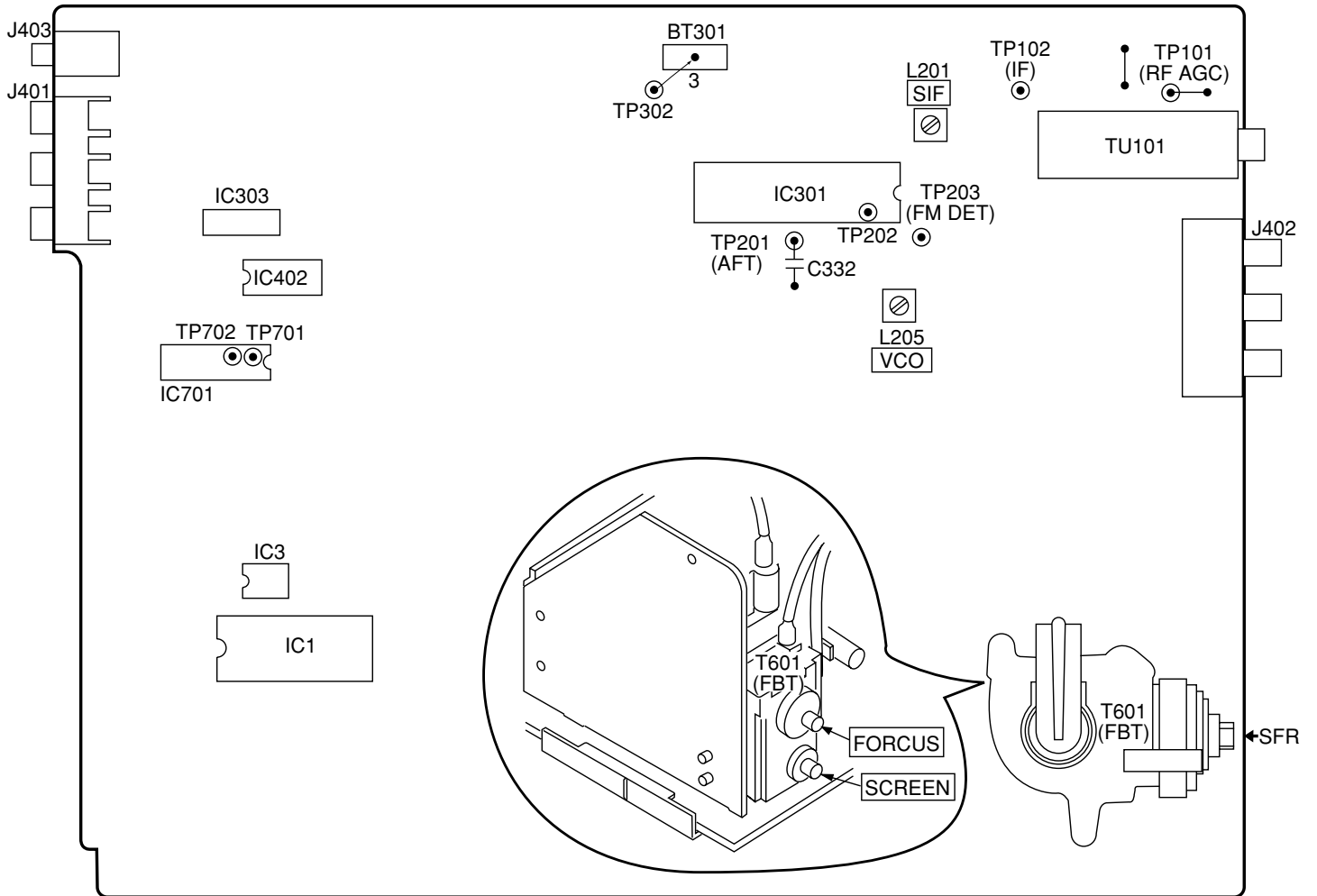

B NK C. B (Top View)

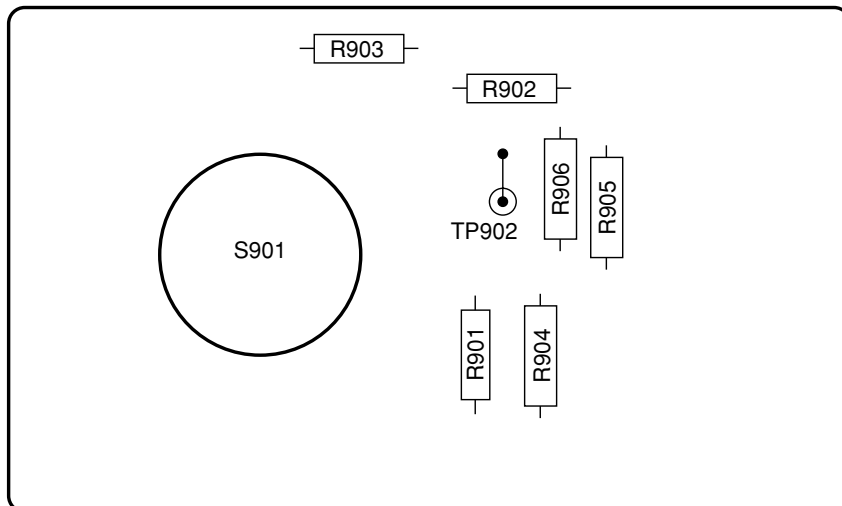

1. Menu Screen Adjustment

- Operate after inputting the following initial figures when replacing EEP ROM.
- Check the condition and adjust the area where the general repair is carried out.

TV-S2011	Initial Figures
PAGE 1	
1. H POS	20
2. V POS	2
3. V SIZE	18
4. OSD POS	6
5. PIF VCO	58
6. RF AGC	32
PAGE 2	
1. R CUT OFF	127
2. G CUT OFF	127
3. B CUT OFF	127
4. G DRIVE	127
5. B DRIVE	127
PAGE 3	
1. SUB CONTRAST	+24
2. SUB BRIGHT	+35
3. SUB TINT	0
4. SUB COLOR	+15
PAGE 4	SPECIFIED FIGURE
1. 3.58 TRAP	ON
2. BPF	AUTO
3. H AFC	+1
4. WPL	OFF
PAGE 5	
1. ATT	10
2. SPECTRAL	31
3. WIDEBAND	31

1-1. **H POS** Horizontal Positioning / Adjustment Menu Screen : PAGE 1-1

Input signal : Crosshatch

Measuring instrument : Pattern generator

- Use the volume keys on the jig remote controller to adjust the dot mark in the centre of crosshatch screen to the exact centering position by allocating an equal number of squares on the left and right sides of the dot. (Fig. 1-1)

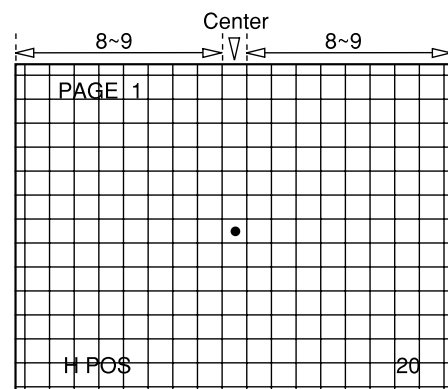

Fig. 1-1

1-2. **V POS** Vertical Positioning / Adjustment Menu Screen : PAGE 1-2

Input signal : Crosshatch

Measuring instrument : Pattern generator

- Using the volume keys on the jig remote controller, adjust the dot mark to the exact vertical centre position in the crosshatch screen. (Fig. 1-2)

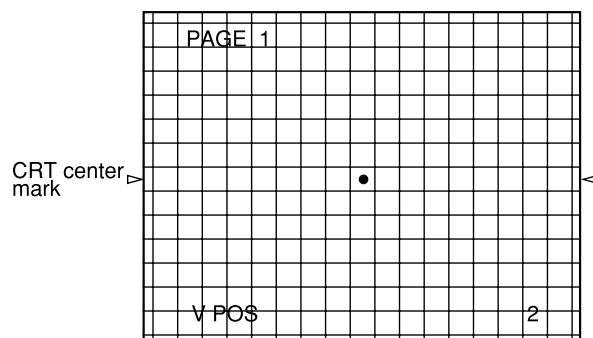

Fig. 1-2

1-3. **V SIZE** Vertical Size Adjustment / Adjustment Menu Screen : PAGE 1-3

Input signal : Crosshatch

Measuring instrument : Pattern generator

- Use the volume keys on the jig remote controller to adjust the vertical number of squares to 13 or 14. (Fig. 1-3)

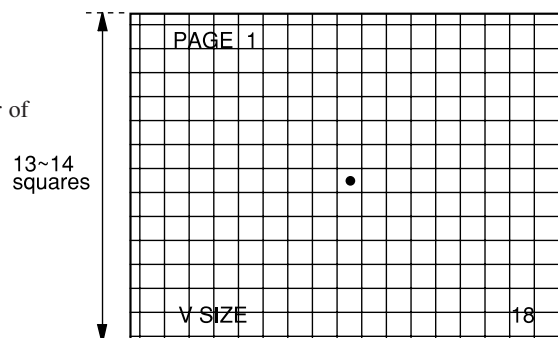

Fig. 1-3

1-4. **OSD POS** OSD Positioning / Adjustment Menu Screen : PAGE 1-4

Input signal : Not specified

- Adjust + mark positions on both left and right in the equal distance towards the screen edge. A = B (Fig. 1-4)

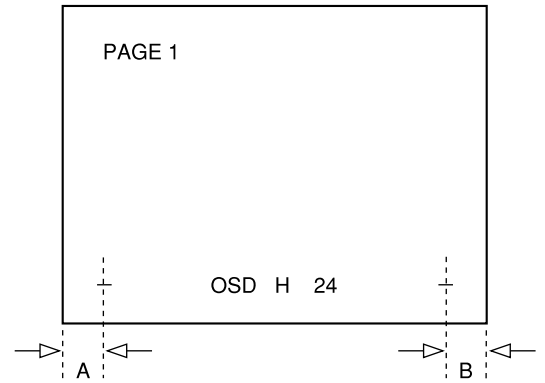

Fig. 1-4

1-5. **PIF VCO** Video IF/VCO Adjustment / Adjustment Menu Screen : PAGE 1-5

Input signal : ANT RF - INPUT

- Use the volume keys on the jig remote controller to adjust AFT until "OK" status is indicated on the screen. (Fig. 1-5)
- If there is more than one range to adjust, select the average figures.

* "NG" will be indicated for SD when no screen signal was sent. It will not be any problem for VCO adjustment. (eg. Video input environment with receiving no signal.) Even in this case, adjustment is possible if there is a load on.

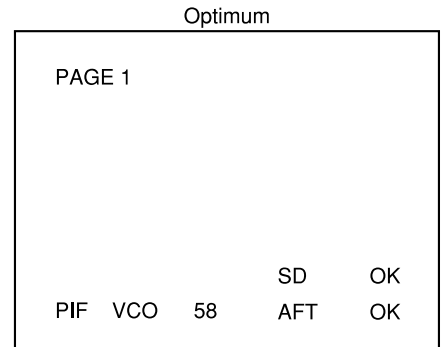

Fig. 1-5

1-6. **RF AGC** RF-AGC / Adjustment Menu Screen : PAGE 1-6

Input signal : ANT RF - INPUT

Test point : TP-101 **RF - AGC** (TU101-1 pin)

Measuring instrument : Oscilloscope

- Connect oscilloscope to TP-101
- Using the volume keys on the jig remote controller, adjust the test point voltage becomes to $3.5V \pm 0.3V$. And at the same time, confirm AFT status changes to "OK" as shown in the fig. 1-6.

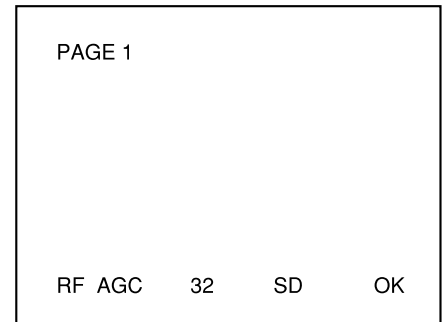

Fig. 1-6

2. White Balance Adjustment : Adjustment Menu Screen : PAGE 2-1~5.

- User's picture quality will be cleared when the adjustment menu screen appears.

Input signal : White raster

Contents of the adjustment :

- | |
|--------------|
| 1. R CUT OFF |
| 2. G CUT OFF |
| 3. B CUT OFF |
| 4. G DRIVE |

* More than 20 minutes of aging is required before adjustment.

- | |
|------------|
| 5. B DRIVE |
|------------|

* The whole process should be repeated for several times for the adjustment.

Measuring instrument : Pattern generator

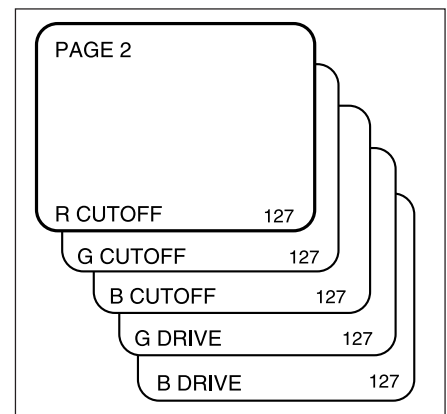

Fig. 2-1

Cut Off Adjustment :

- Use the pattern generator to input the white raster signal.
- Using the volume keys on the jig remote controller, fix the figure of the strongest color on the screen to the level 127 and adjust the other 2 cut off figures until a white picture appears on the screen. Fig. 2-1

Drive Adjustment :

- 2-3. Using the volume keys on the jig remote controller, bring the figure of **4. G DRIVE** up to more than 200 till the color becomes greenish.
- 2-4. Reduce the numeric figure to the point where the greenish color disappears completely.
- 2-5. Use the volume keys on the jig remote controller to increase the numeric figure of **5. B DRIVE** up to more than 200 till the color becomes bluish.
- 2-6. Reduce the numeric figure to the point where the bluish color disappears completely.
- 2-7. Repeat the process of 2-1 to 2-6 for several times and adjust for whiter look.

Focus Adjustment :

Input signal : Dot pattern
 Adjustment point : SFR located at upper part of FBT (T601)
 Measuring instrument : Pattern generator

- Adjust SFR which is located at upper part of FBT (T601) in order to get the best focus point for the dot.

3. Screen Adjustment :

Input signal : No signal (No raster)
 Adjustment point : SFR located at lower part of FBT (T601)
 Measuring instrument: Pattern generator / Leader : LCG-404

- 1. Enter to the “Adjustment Menu Screen” by using the jig remote controller.
- 2. Press “0” key of the 10 numeric channel keypad to get a horizontal single line screen. (Fig. 2-2)
- 3. Adjust SFR located at the lower part of FBT (T601) until the horizontal line starts to be slightly brightened.
- 4. Repeat the process of step 2 and return to the “Adjustment Menu Screen”.



Fig. 2-2

- 3-1. **SUB BRIGHT** Sub-brightness Adjustment / Adjustment Menu Screen : PAGE 3-2 (make sure of the order)
 Input signal : Color bar (Stair step)
 Measuring instrument : Pattern generator
- 1. Using the volume keys on the jig remote controller, adjust the scale of the second last from right to be slightly brightened. (Fig. 3-1)

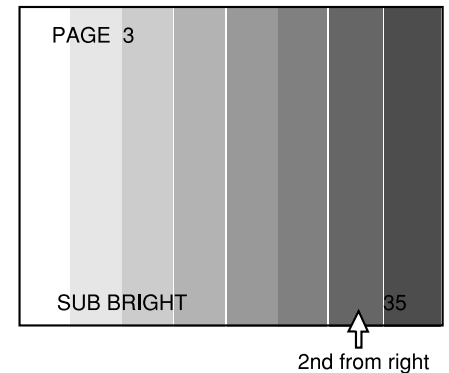

Fig. 3-1

- 3-2. **SUB CONTRAST** Sub-contrast Adjustment / Adjustment Menu Screen : PAGE 3-1
 Input signal : Color bar (QIW), Chroma / Off
 Measuring instrument : Oscilloscope
 Pattern generator
- Test point : TP902/NK C.B.
- 1. Connect oscilloscope to TP902.
- 2. Using the volume keys on the jig remote controller, adjust the voltage between pedestal level and 100% white to $80V \pm 2.0V$ as shown in the Fig 3-2.

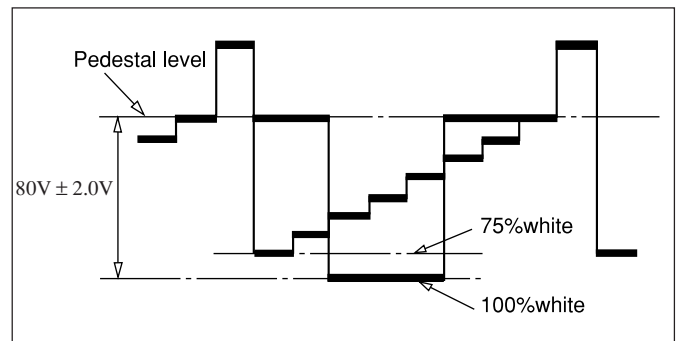

Fig. 3-2

- 3-3. **SUB TINT** Sub-tint Adjustment / Adjustment Menu Screen : PAGE 3-3
 Input signal : Color bar
 VIDEO IN
 Measuring instrument : Oscilloscope
 Pattern generator
- Test Point : TP302/BT301 (wire connector) 3 pin
- 1. Connect oscilloscope to TP302.
- 2. Use the volume keys on the jig remote controller to align each bottom point of the waveform tangential to the linear ramp as shown in Fig 3-3.

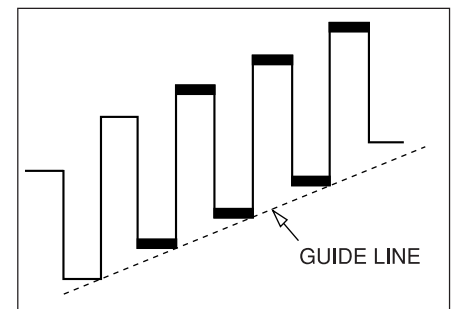

Fig. 3-3

3-4. **SUB COLOR** Sub-color Adjustment / Adjustment Menu Screen : PAGE 3-4

Input signal : Color bar

VIDEO IN

Measuring instrument : Oscilloscope

Pattern generator

Test point : TP302/BT301(wire connector) 3 pin

1. Connect oscilloscope to TP302
2. Use the volume keys of the jig remote controller and adjust the top and bottom excursions of waveform to be linear as shown in the Fig. 3-4.

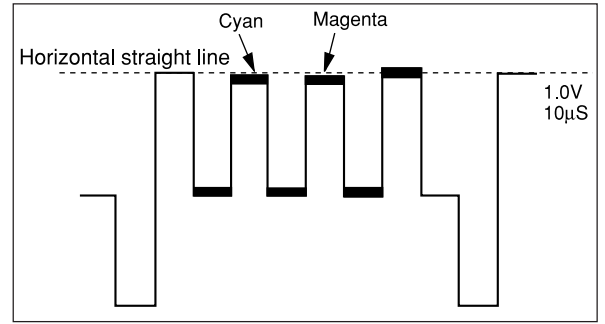

Fig. 3-4

4. **TV SETTING CHECK** Checking of Setting per Model Basis / Adjustment Menu Screen : PAGE 1~4

The setting details are fixed per model basis. Do not set other than specified.

- Check whether the adjustment menu screen is matching to the table-4. If not, use the volume keys on the jig remote controller to search and set the matching menu screen to the model.

3.58 TRAP	0 : ON
BPF	2 : AUTO
H AFC	1 : +1
WPL	0 : OFF

* The contents for 3.58 TRAP can not be modified.
Table-4

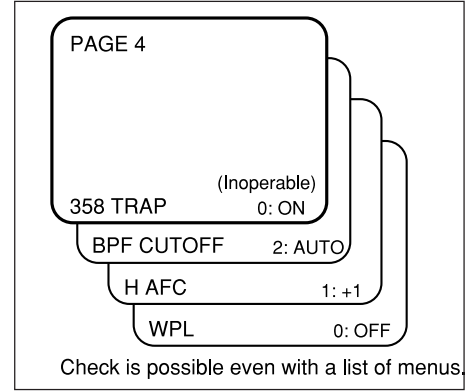

Fig. 4

5-1. **ATT ALIGNMENT** ATT Adjustment / Adjustment Menu Screen : PAGE 5-1

Input signal : ANT RF-Input

Measuring instrument : Oscilloscope

Test point : IC701 2 pin **TV-L**

1. Connect oscilloscope to TP702 (IC701 2 pin)
2. Use the volume keys on the jig remote controller and adjust the figure for IC701 2 pin to $490V \pm 20m$ Vrms.

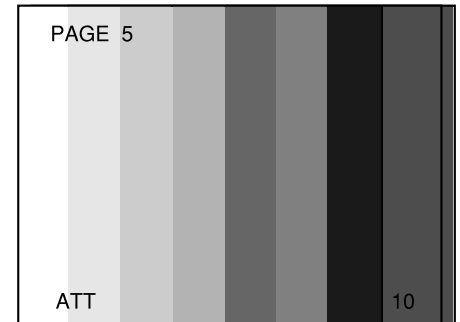

Fig. 5-1

5-2. **SEPARATION ALIGNMENT** Stereo Audio Segregating Adjustment / Adjustment Menu screen : PAGE 5-2 to 5-3

Input signal : Setting of TV audio multiple signal equipment

Modulation	Internal
Internal Modulation	400Hz
Audio	L ch
Channel	2 ch
Video Signal	Color Bar

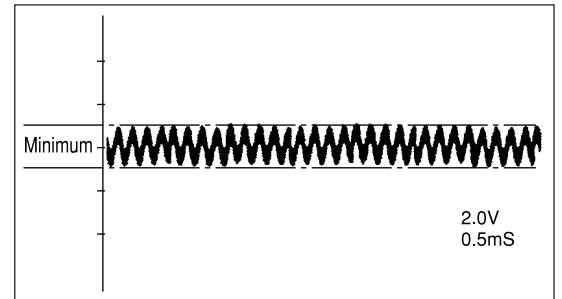

Fig. 5-2

- RF output for Audio multiple signal generator/2CH

Measuring instrument : Oscilloscope

TV audio multiple signal generator

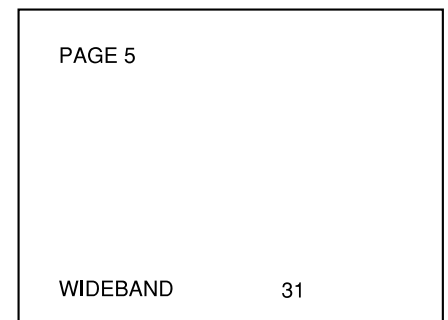

Fig. 5-3

Test Point : IC701 1 pin **TV-R**

- 1.Connect oscilloscope to TP701 (IC701 1 pin).
- 2.Receive TV channel 2.
- 3.PAGE 5-3

Use the volume keys on the jig remote controller to adjust IC701 1 pin to the minimum voltage waveform as shown in the Fig. 5-2 (Fig. 5-3)

4. PAGE 5-2

Set internal modulation of TV audio multiple signal generator to 1kHz. Proceed to adjust as explained in the previous paragraph 3. (Fig. 5-4)

- 5.Repeat the process of 3 to 4 and set them to the minimum levels.

PAGE 5

SPECTRAL

31

Fig. 5-4

6. Tuner Adjustment :

Perform the following adjustment in case of replacing any adjustment element during the repair. Proceed with the following adjustments as well as in the adjustment menu screen. If those adjustments are not completed on both sides, the required adjustment will not be registered even though the adjustment has been processed in the adjustment menu screen.

The components which will be affected due to the repair.

- VCO Coil
- SIF Coil

6-1. **VCO ADJUSTMENT** VCO(PIF) adjustment / Video Carrier Frequency Free Running Adjustment

Input signal : RF-color bar (Generator)

Input level : 90dB μ V (Level may not be exactly the same depends on the receiving condition)

Broadcast CH/fc=45.75MHz

- Simple adjustment method receives normal broadcasting.

Mode : TUNER

Test point : INPUT/TP-102 **IF** (TU101-11 pin) or receiving condition

OUTPUT/TP-201 **AFT** (IC301-44 pin)

Adjustment point : L205/**P-IF**

Measuring instrument : Oscilloscope

Pattern generator

1. Connect oscilloscope to TP-201.
2. Input specified level of RF signal to TP-102 and adjust L205 until TP-201 voltage becomes 2.8V \pm 0.2VDC.

6-2. **SIF ADJUSTMENT** Stereo IF Modulation Adjustment

Input signal : AM/FM-SG RF OUT/4.5MHz - SIF

MOD OFF

90dB μ V

- Simple adjustment method receives normal broadcasting.

Mode : TUNER

Test point : INPUT/TP-202 : IC301-52 pin

OUTPUT/TP-203 : IC301-54 pin

Adjustment point : L201/**S-IF**

Measuring instrument : Oscilloscope

AM/FM-Signal generator

1. Connect oscilloscope to TP-203.
2. Input specified signal to TP-202 (or receiving condition) and adjust L201 until TP-203 voltage becomes 4.5V \pm 0.2VDC. (Fig. 6-1)

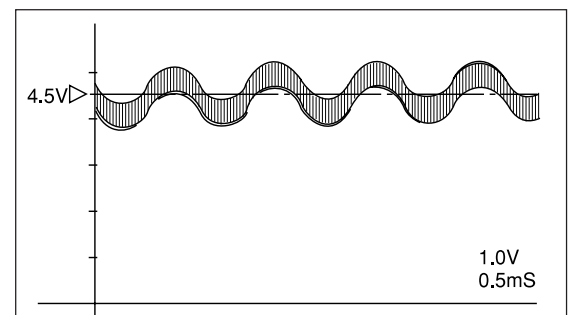

Fig. 6-1

Setting of IIC BUS Data

This model is designed to adjust most parts of the image projection and deflection system by using the jig remote controller.

Preparations :

- Modify the hidden keys on the RC-6VT06 jig remote controller (TV-C142/86-LB4-951-010) so that they can easily be pressed.
2 keys to be modified. (Refer to the below illustration)

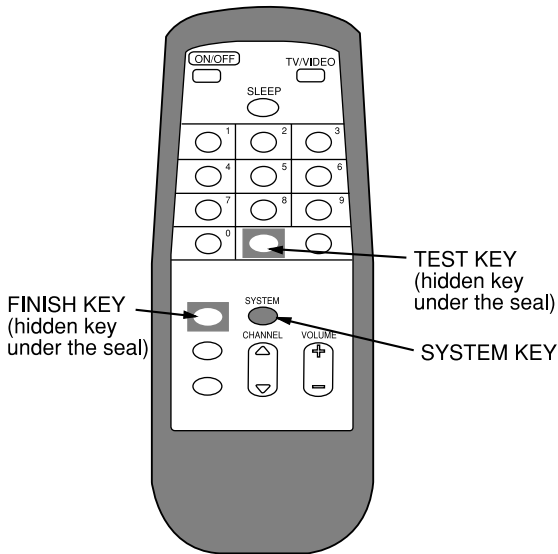

Starting the "Service Mode" :

Hidden key / "TEST"

- Press the "TEST" key on the jig remote controller once to enter to the "Aging Mode" (Refer Fig. 1).
- Press the "TEST" key on the jig remote controller one more time to enter to the "Adjustment Mode".

Hidden key / "FINISH"

- The accumulated hours in the "Aging Mode" will be reset by pressing the "FINISH" key on the jig remote controller.
- Do not press this during general repairs.

Aging Mode Operation Method :

Make sure that confirmation after replacing EEP ROM.

- Press the "TEST" key on the jig remote controller and enter to the aging mode.
(Refer to Fig. 1)
- Press the "SYSTEM" key to check the status of distinction switch
 - If the contents are different, choose [NH2] by pressing the "2" key for the destinations.
 - For the data, move 1 - 16 by using channel keys and change to "0" or "1".
 - Select "TV-S2011/[NH2] and leave the data as being displayed.
(Fig. 2).

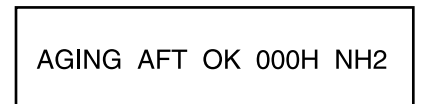

Fig. 1

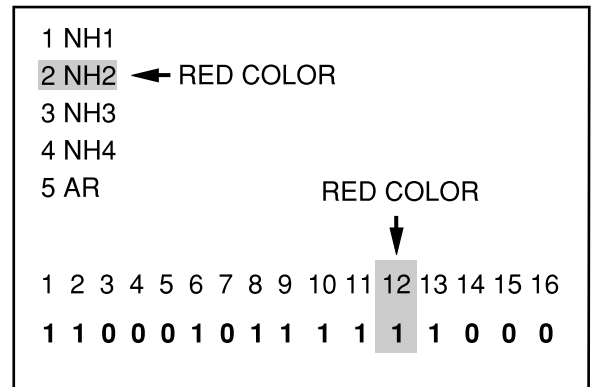
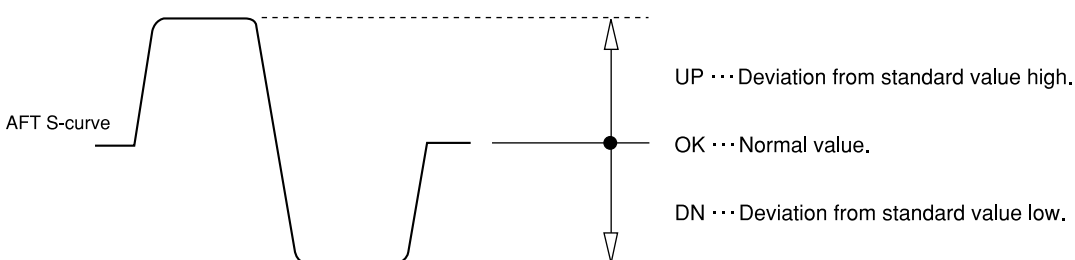

Fig. 2

Contents of Aging Mode :

- Release "Auto Power Off" function
Release "Auto Power Off" function when no input is supplied.
Use this mode for warming up (aging) during CRT adjustment.
- AFT S-curve status indication
The condition of AFT S-curves are indicated by "OK" for suitable tuning, "UP" for too high or "DN" for too low.



3. Display of "CRT ON" accumulated hours
 The CRT usage time is accumulated on an hourly basis and is displayed in hexadecimal figures.

Sample calculation of displayed hexadecimal figures : AFT OK 1234 H NH2

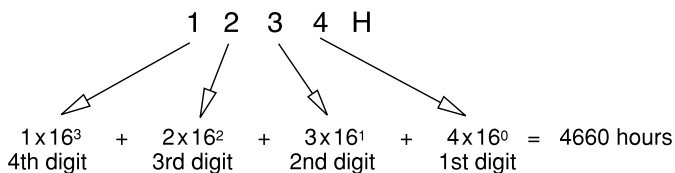

- The display will be reset to 0000H when the accumulated hours exceed 7FFFH(32768 hours).

Adjustment Mode Operation Method :

- Return to the aging display by pressing the "SYSTEM" key and press "TEST" key once again to enter into the adjustment menu screen.

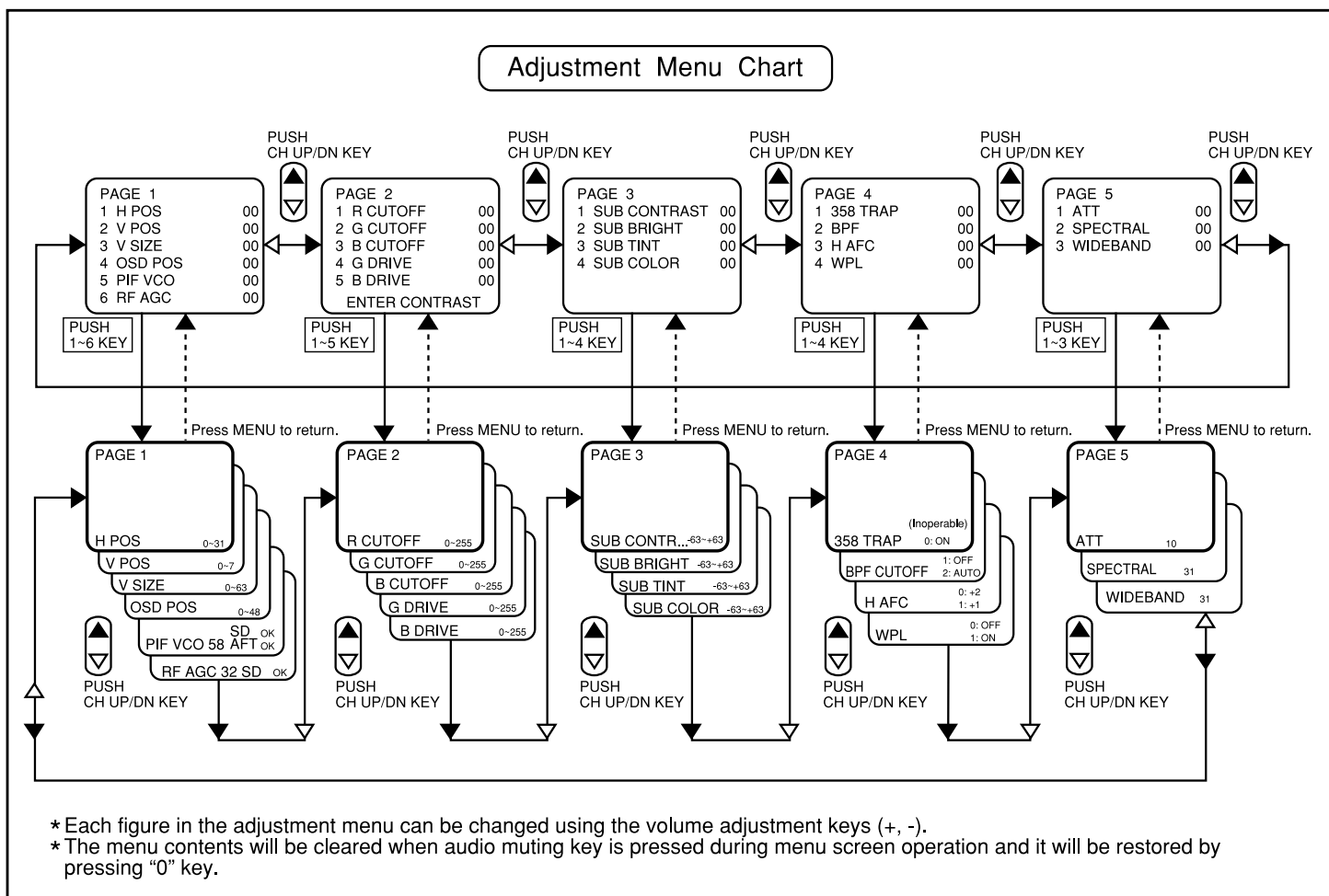

Fig. 3

アイワ株式会社 〒110-8710 東京都台東区池之端1-2-11 ☎03(3827)3111 (代表)
AIWA CO.,LTD. 2-11, IKENOHATA 1-CHOME, TAITO-KU, TOKYO 110, JAPAN TEL:03 (3827) 3111